

# DATA SHEET

For a complete data sheet, please also download:

- The IC06 74HC/HCT/HCU/HCMOS Logic Family Specifications
- The IC06 74HC/HCT/HCU/HCMOS Logic Package Information
- The IC06 74HC/HCT/HCU/HCMOS Logic Package Outlines

## **74HC/HCT14** Hex inverting Schmitt trigger

Product specification  
File under Integrated Circuits, IC06

September 1993

## Hex inverting Schmitt trigger

## 74HC/HCT14

## FEATURES

- Output capability: standard
- $I_{CC}$  category: SSI

## GENERAL DESCRIPTION

The 74HC/HCT14 are high-speed Si-gate CMOS devices and are pin compatible with low power Schottky TTL (LSTTL). They are specified in compliance with JEDEC standard no. 7A.

The 74HC/HCT14 provide six inverting buffers with Schmitt-trigger action. They are capable of transforming slowly changing input signals into sharply defined, jitter-free output signals.

## QUICK REFERENCE DATA

GND = 0 V;  $T_{amb} = 25\text{ }^{\circ}\text{C}$ ;  $t_r = t_f = 6\text{ ns}$

SYMBOL	PARAMETER	CONDITIONS	TYPICAL		UNIT
			HC	HCT	
$t_{PHL}/t_{PLH}$	propagation delay nA to nY	$C_L = 15\text{ pF}$ ; $V_{CC} = 5\text{ V}$	12	17	ns
$C_I$	input capacitance		3.5	3.5	pF
$C_{PD}$	power dissipation capacitance per gate	notes 1 and 2	7	8	pF

## Notes

1.  $C_{PD}$  is used to determine the dynamic power dissipation ( $P_D$  in  $\mu\text{W}$ ):

$$P_D = C_{PD} \times V_{CC}^2 \times f_i + \sum (C_L \times V_{CC}^2 \times f_o) \text{ where:}$$

$f_i$  = input frequency in MHz

$f_o$  = output frequency in MHz

$C_L$  = output load capacitance in pF

$V_{CC}$  = supply voltage in V

$\sum (C_L \times V_{CC}^2 \times f_o)$  = sum of outputs

2. For HC the condition is  $V_I = \text{GND to } V_{CC}$   
For HCT the condition is  $V_I = \text{GND to } V_{CC} - 1.5\text{ V}$

## ORDERING INFORMATION

See "74HC/HCT/HCU/HCMOS Logic Package Information".

# Hex inverting Schmitt trigger

# 74HC/HCT14

## PIN DESCRIPTION

PIN NO.	SYMBOL	NAME AND FUNCTION
1, 3, 5, 9, 11, 13	1A to 6A	data inputs
2, 4, 6, 8, 10, 12	1Y to 6Y	data outputs
7	GND	ground (0 V)
14	V <sub>CC</sub>	positive supply voltage

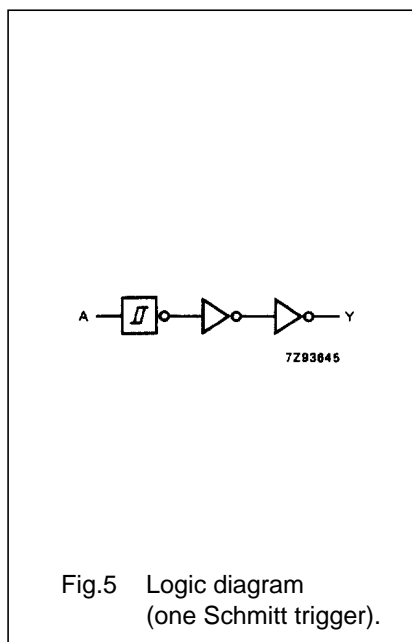
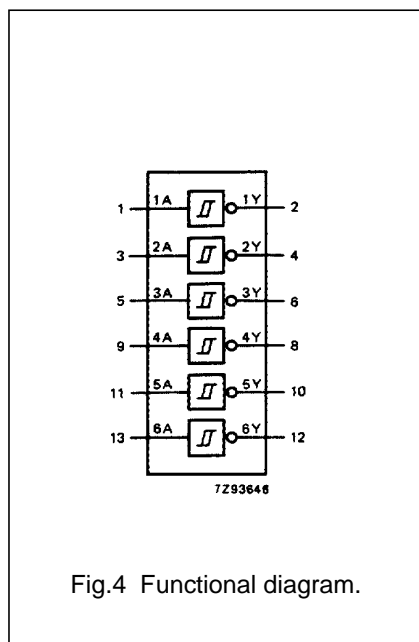
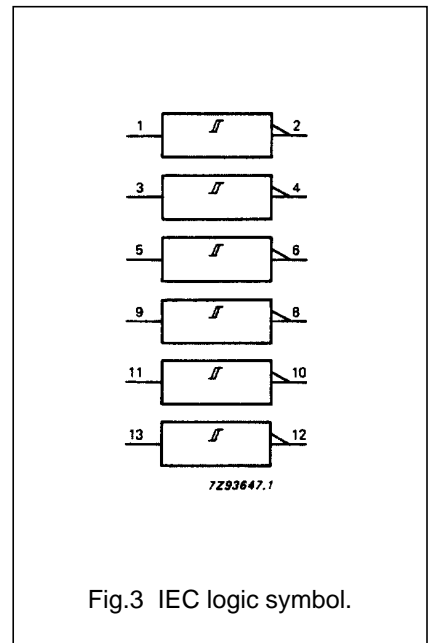
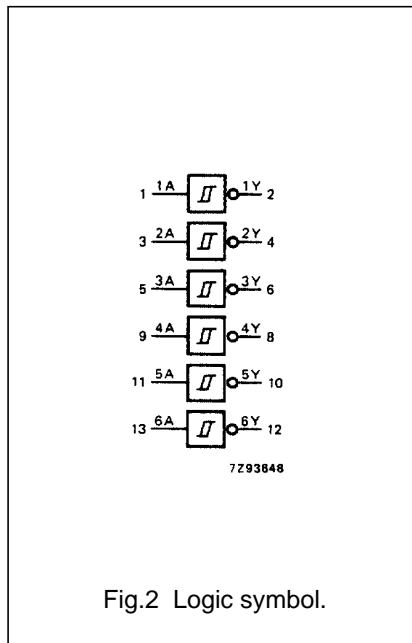
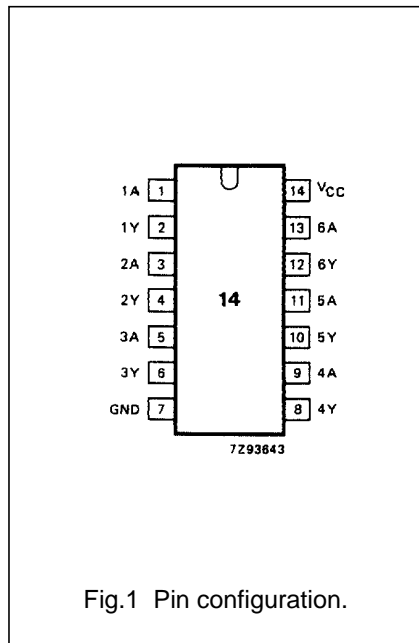

## FUNCTION TABLE

INPUT	OUTPUT
nA	nY
L	H
H	L

### Notes

1. H = HIGH voltage level  
L = LOW voltage level

### APPLICATIONS

- Wave and pulse shapers
- Astable multivibrators
- Monostable multivibrators

## Hex inverting Schmitt trigger

## 74HC/HCT14

**DC CHARACTERISTICS FOR 74HC**

For the DC characteristics see *"74HC/HCT/HCU/HCMOS Logic Family Specifications"*. Transfer characteristics are given below.

Output capability: standard

I<sub>CC</sub> category: SSI

**Transfer characteristics for 74HC**

Voltages are referenced to GND (ground = 0 V)

SYMBOL	PARAMETER	T <sub>amb</sub> (°C)								UNIT	TEST CONDITIONS	
		74HC									V <sub>CC</sub> (V)	WAVEFORMS
		+25			-40 to +85		-40 to +125					
		min.	typ.	max.	min.	max.	min.	max.				
V <sub>T+</sub>	positive-going threshold	0.7 1.7 2.1	1.18 2.38 3.14	1.5 3.15 4.2	0.7 1.7 2.1	1.5 3.15 4.2	0.7 1.7 2.1	1.5 3.15 4.2	V	2.0 4.5 6.0	Figs 6 and 7	
V <sub>T-</sub>	negative-going threshold	0.3 0.9 1.2	0.52 1.40 1.89	0.90 2.00 2.60	0.3 0.90 1.20	0.90 2.00 2.60	0.30 0.90 1.2	0.90 2.00 2.60	V	2.0 4.5 6.0	Figs 6 and 7	
V <sub>H</sub>	hysteresis (V <sub>T+</sub> - V <sub>T-</sub> )	0.2 0.4 0.6	0.66 0.98 1.25	1.0 1.4 1.6	0.2 0.4 0.6	1.0 1.4 1.6	0.2 0.4 0.6	1.0 1.4 1.6	V	2.0 4.5 6.0	Figs 6 and 7	

**AC CHARACTERISTICS FOR 74HC**

GND = 0 V; t<sub>f</sub> = t<sub>r</sub> = 6 ns; C<sub>L</sub> = 50 pF

SYMBOL	PARAMETER	T <sub>amb</sub> (°C)								UNIT	TEST CONDITIONS	
		74HC									V <sub>CC</sub> (V)	WAVEFORMS
		+25			-40 to +85		-40 to +125					
		min.	typ.	max.	min.	max.	min.	max.				
t <sub>PHL</sub> / t <sub>PLH</sub>	propagation delay nA to nY		41 15 12	125 25 21		155 31 26		190 38 32	ns	2.0 4.5 6.0	Fig.8	
t <sub>THL</sub> / t <sub>TLH</sub>	output transition time		19 7 6	75 15 13		95 19 15		110 22 19	ns	2.0 4.5 6.0	Fig.8	

## Hex inverting Schmitt trigger

## 74HC/HCT14

**DC CHARACTERISTICS FOR 74HCT**

For the DC characteristics see *"74HC/HCT/HCU/HCMOS Logic Family Specifications"*. Transfer characteristics are given below.

Output capability: standard

$I_{CC}$  category: SSI

**Note to HCT types**

The value of additional quiescent supply current ( $\Delta I_{CC}$ ) for a unit load of 1 is given in the family specifications.

To determine  $\Delta I_{CC}$  per input, multiply this value by the unit load coefficient shown in the table below.

INPUT	UNIT LOAD COEFFICIENT
nA	0.3

**Transfer characteristics for 74HCT**

Voltages are referenced to GND (ground = 0 V)

SYMBOL	PARAMETER	$T_{amb}$ (°C)								UNIT	TEST CONDITIONS	
		74HCT									$V_{CC}$ (V)	WAVEFORMS
		+25			-40 to +85		-40 to +125					
		min.	typ.	max.	min.	max.	min.	max.				
$V_{T+}$	positive-going threshold	1.2	1.41	1.9	1.2	1.9	1.2	1.9	V	4.5 5.5	Figs 6 and 7	
$V_{T-}$	negative-going threshold	0.5	0.85	1.2	0.5	1.2	0.5	1.2	V	4.5 5.5	Figs 6 and 7	
$V_H$	hysteresis ( $V_{T+} - V_{T-}$ )	0.4	0.56	–	0.4	–	0.4	–	V	4.5 5.5	Figs 6 and 7	

**AC CHARACTERISTICS FOR 74HCT**

GND = 0 V;  $t_r = t_f = 6$  ns;  $C_L = 50$  pF

SYMBOL	PARAMETER	$T_{amb}$ (°C)								UNIT	TEST CONDITIONS	
		74HCT									$V_{CC}$ (V)	WAVEFORMS
		+25			-40 to +85		-40 to +125					
		min.	typ.	max.	min.	max.	min.	max.				
$t_{PHL} / t_{PLH}$	propagation delay nA, to nY		20	34		43		51	ns	4.5	Fig.8	
$t_{THL} / t_{TLH}$	output transition time		7	15		19		22	ns	4.5	Fig.8	

# Hex inverting Schmitt trigger

# 74HC/HCT14

## TRANSFER CHARACTERISTIC WAVEFORMS

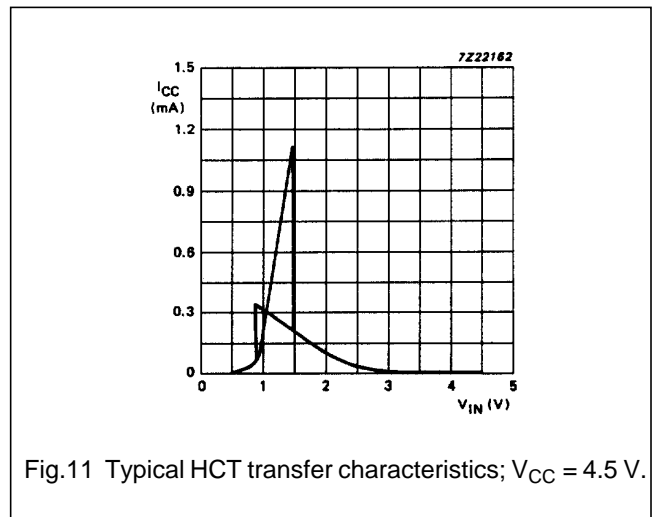
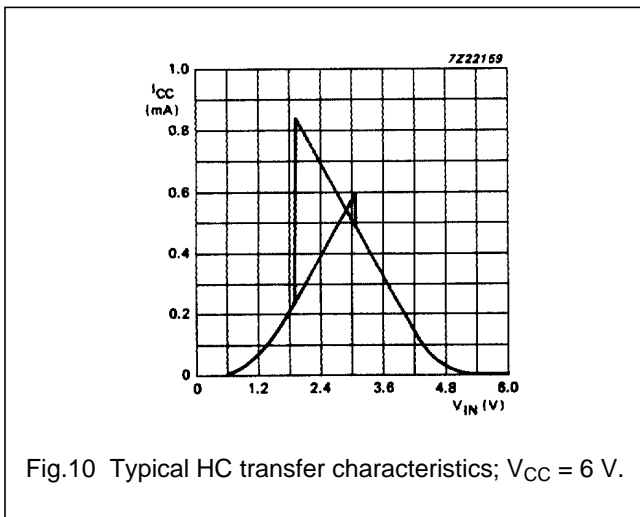
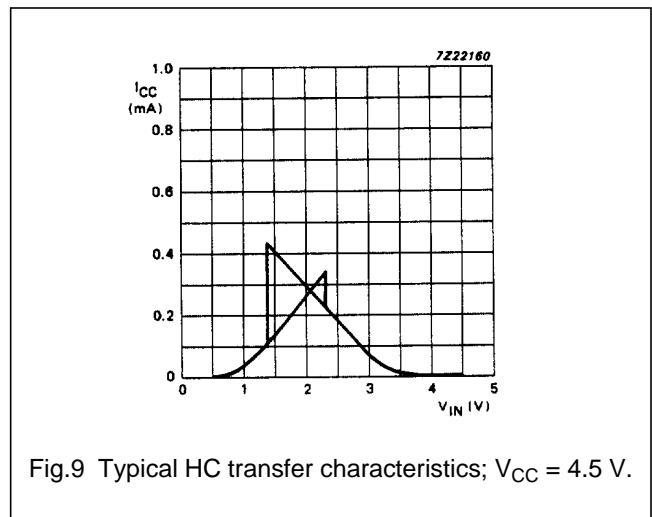
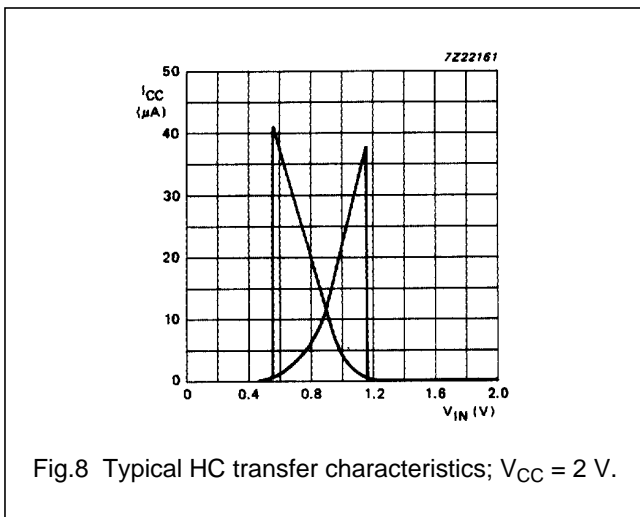
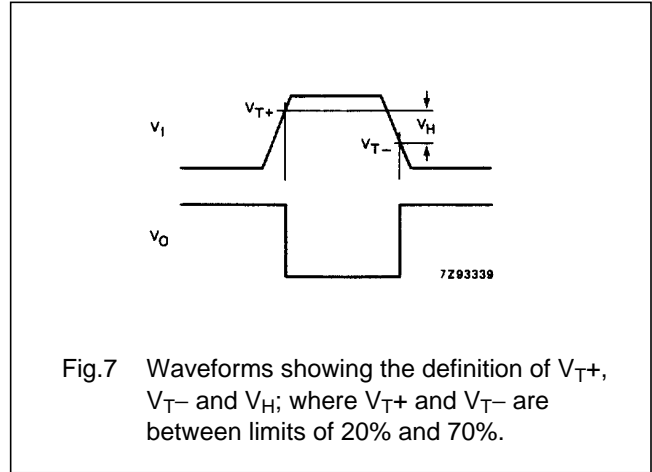
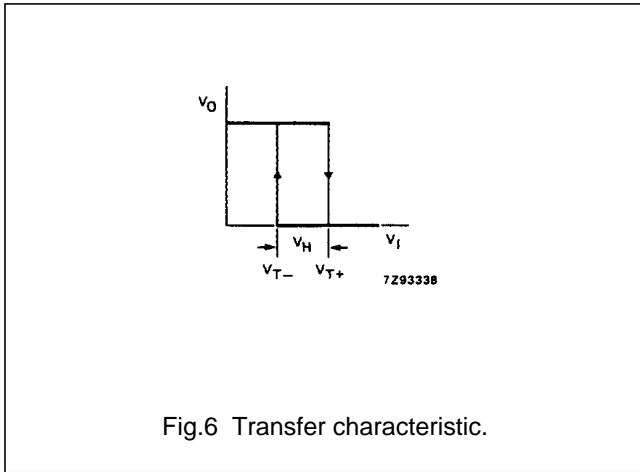

# Hex inverting Schmitt trigger

# 74HC/HCT14

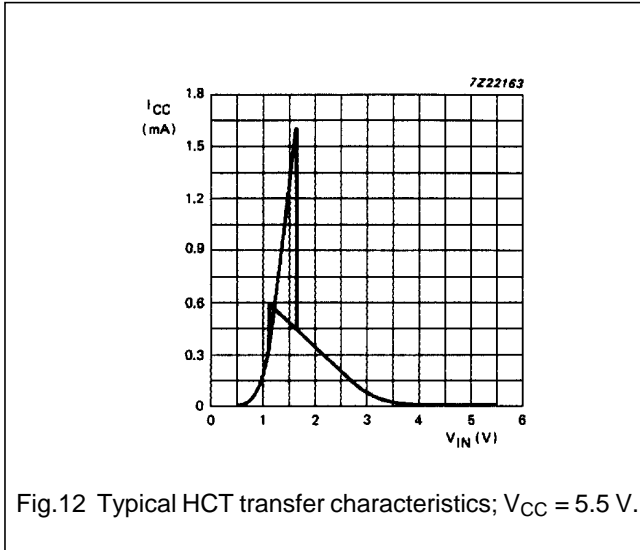
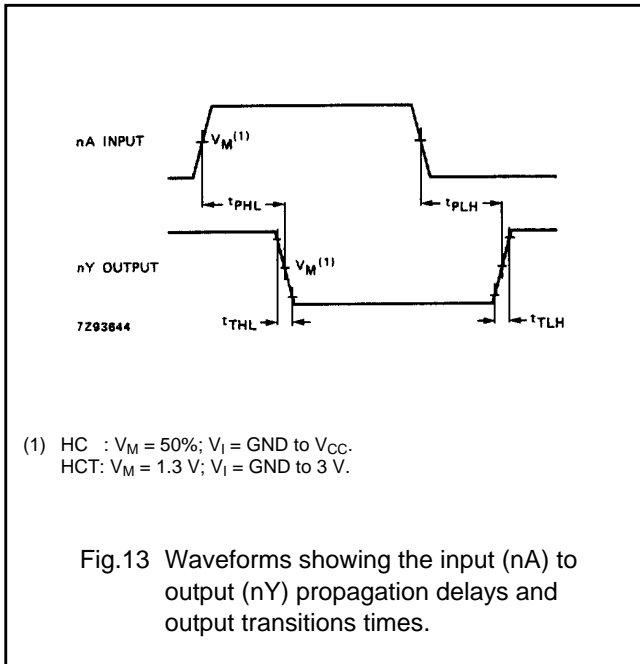

Fig.12 Typical HCT transfer characteristics;  $V_{CC} = 5.5\text{ V}$ .

## AC WAVEFORMS



# Hex inverting Schmitt trigger

# 74HC/HCT14

## APPLICATION INFORMATION

The slow input rise and fall times cause additional power dissipation, this can be calculated using the following formula:

$$P_{ad} = f_i \times (t_r \times I_{CCa} + t_f \times I_{CCa}) \times V_{CC}$$

Where:

- $P_{ad}$  = additional power dissipation ( $\mu W$ )
- $f_i$  = input frequency (MHz)
- $t_r$  = input rise time ( $\mu s$ ); 10% – 90%
- $t_f$  = input fall time ( $\mu s$ ); 10% – 90%
- $I_{CCa}$  = average additional supply current ( $\mu A$ )

Average  $I_{CCa}$  differs with positive or negative input transitions, as shown in Figs 14 and 15.

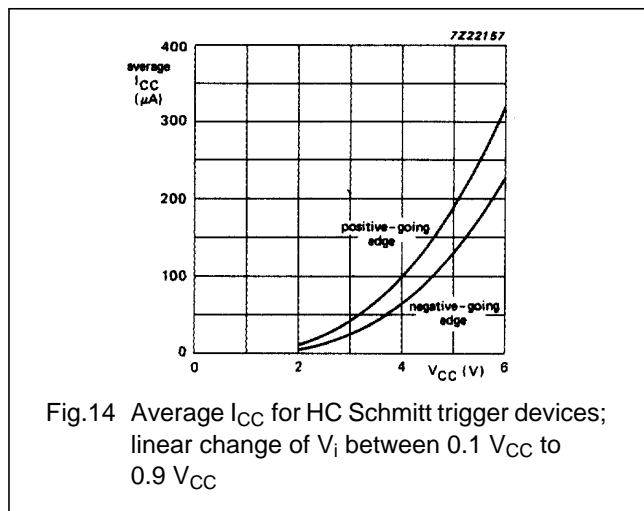

Fig.14 Average  $I_{CC}$  for HC Schmitt trigger devices; linear change of  $V_i$  between  $0.1 V_{CC}$  to  $0.9 V_{CC}$

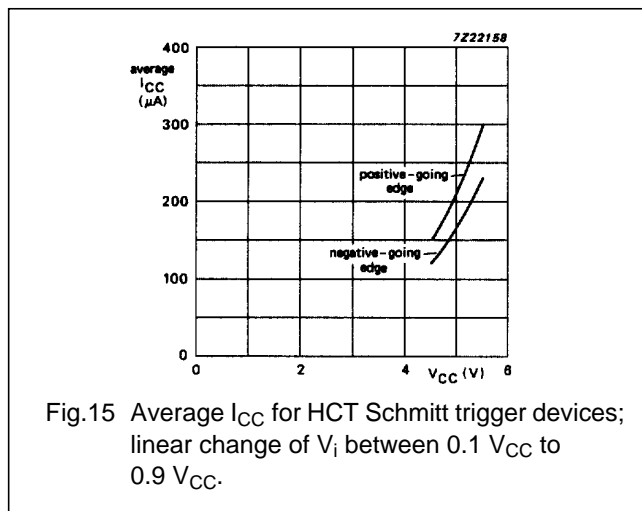
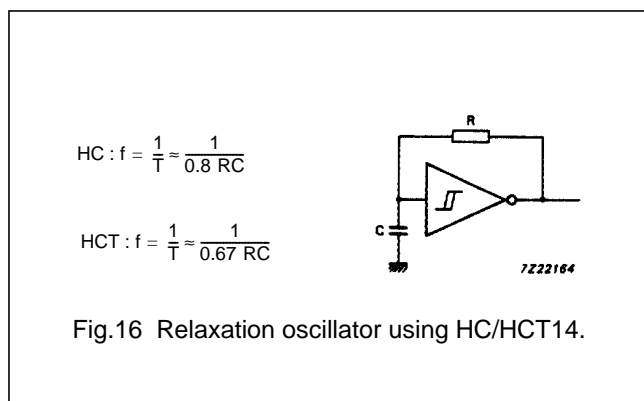

Fig.15 Average  $I_{CC}$  for HCT Schmitt trigger devices; linear change of  $V_i$  between  $0.1 V_{CC}$  to  $0.9 V_{CC}$ .

HC/HCT14 used in a relaxation oscillator circuit, see Fig.16.



### Note to Application information

All values given are typical unless otherwise specified.

### PACKAGE OUTLINES

See "74HC/HCT/HCU/HCMOS Logic Package Outlines".



This datasheet has been download from:

[www.datasheetcatalog.com](http://www.datasheetcatalog.com)

Datasheets for electronics components.